



Model Number GR3-CI-TF-254TC-4-BR-D-15-230|460-60

MFG PN TFC254T15U4B

List Price --

All data shown at HIGH voltage setting

Format STD 3 Phase

Electrical Data		General Data	
Rated Motor Output Power	15 HP	Frame Size	254
Rated Motor Speed	1770 r/min	Enclosure	TEFC
Rated Motor Voltage (3 Phase)	230 460-60 Volts - HZ	Approximate Weight	246.4
Rated Motor Current	35.4/17.7 Amps	NEMA Design	BE
Service Factor	1.25	IP Rating	55
KVA Code	J	Insulation Class	F
Nominal Efficiency	92.4 %	Tropicalization	YES
Nominal Power Factor	0.86 cosθ	Duty	Cont.
Full Load Torque Ft-Lb	44.256 Ft-Lb	Cable Entry	1.25
Temp Rise @ Full Load °C	30.1	Feet Removable	YES
Efficiency Level	IE3 - NEMA Premium	Double Drilled	NO

Load Data	RPM	Trq %FL	Current Amps	Mechanical Data	
Locked Rotor	-	250	142	Rated Ambient (°C)	40
Breakdown	-	327	-	Rated Altitude (M)	1000
Pull Up	-	171	-	Coating	7024 - Graphite Grey
125% of FL	1763	-	21.79	Shaft Grounding	NO
75% of FL	1779	-	13.84	Brake Voltage (DC)	
50% of FL	1787	-	10.56	Brake Torque (N-M)	
No Load	1797	-	6.87	Bearing DE Side	6309 C3

Hazardous Location	Class 1, Div 2, Grp A,B,C,D		Moment of Inertia	kg.m2
			Noise Level	Per NEMA dB (A)

CT VFD Range	--	Loaded Torque Curves		--
$P_1 = \text{INPUT POWER (KW)}$, $S = \text{Slip (\% of Sync RPM)}$, $\eta = \text{Efficiency (\%)}$, $\cos\phi = \text{Power Factor}$				

Certifications	UL	CSA	DOE
File Numbers	323353	224693	096A
Wiring Diagram	3PH 12 Lead Dual Voltage		

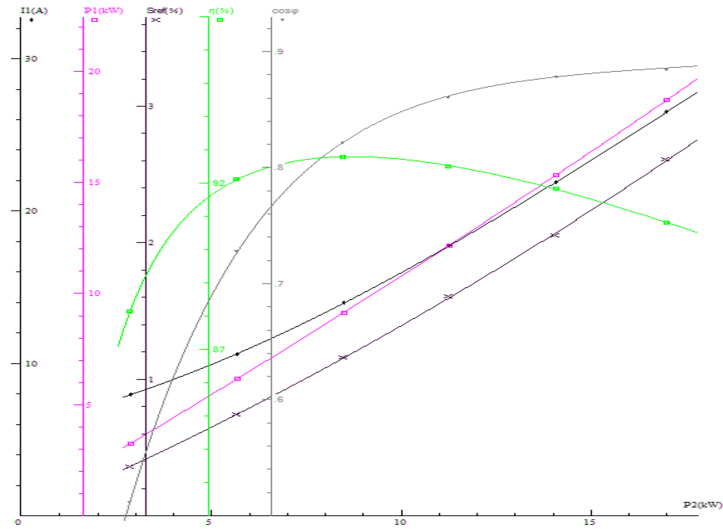
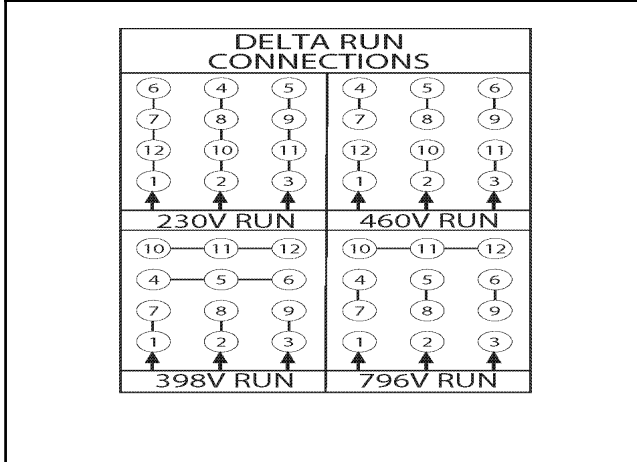

Model Number	GR3-CI-TF-254TC-4-BR-D-15-230 460-60
MFG PN	TFC254T15U4B
List Price	--
Base Frame	GR-254TC-CI-TF

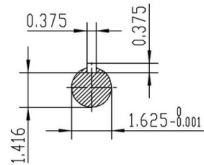
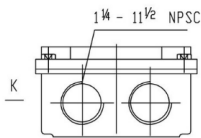
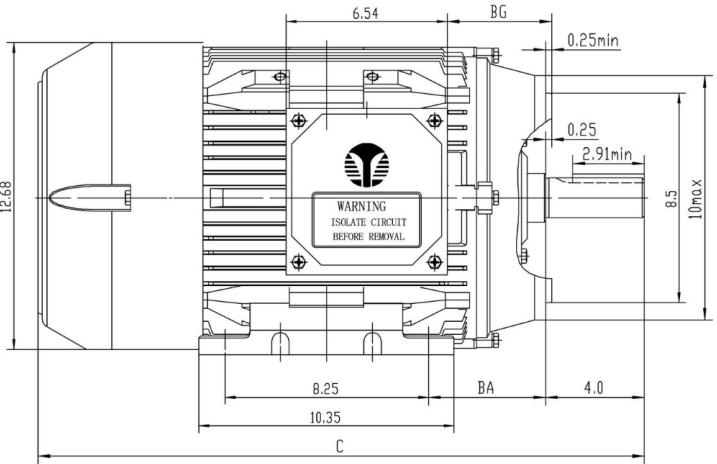
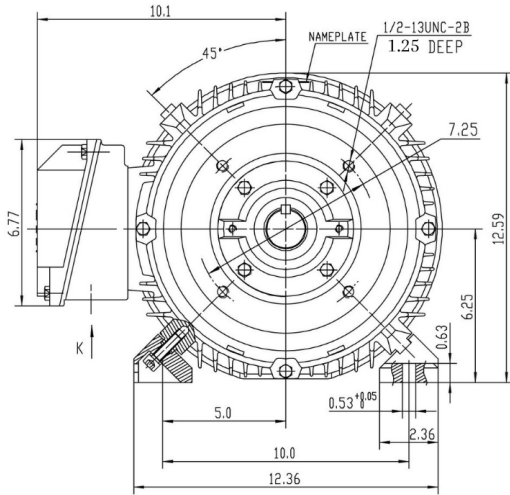

Model	BA	BG	C	NO.
254 KITC	4.25	3.74	24.28	BHMY.010.C064

 ShangHai HIMAK Electrical Machinery CO.,LTD			TEFC 254TC/KITC CFC	
			NO:	1HMY.010.C063-064
Design	yang	Standard	STEP MARK	1:3.5 SORT Cast iron Motor
Checker		Allow		
Auditing		Date		