



Model Number GR3-AL-TF-63B35-4-B-D-.18-230|460-60

MFG PN T 631-4

List Price --

All data shown at HIGH voltage setting

Format | STD 3 Phase

Electrical Data				General Data	
Rated Motor Output Power	0.18 HP			Frame Size	63
Rated Motor Speed	1715 r/min			Enclosure	TEFC
Rated Motor Voltage (3 Phase)	230 460-60 Volts - HZ			Approximate Weight	11.22
Rated Motor Current	0.74/0.37 Amps			NEMA Design	B
Service Factor	1.15			IP Rating	55
KVA Code	J			Insulation Class	F
Nominal Efficiency	66 %			Tropicalization	YES
Nominal Power Factor	0.61 cosθ			Duty	Cont.
Full Load Torque Ft-Lb	0.486816 Ft-Lb			Cable Entry	M16 X 1.5
Temp Rise @ Full Load °C	32.7			Feet Removable	YES
Efficiency Level	IE3 - NEMA Premium			Double Drilled	NO
Load Data	RPM	Trq %FL	Current Amps	Rated Ambient (°C)	40
Locked Rotor	-	259	1.47	Rated Altitude (M)	1000
Breakdown	-	290	-	Coating	7024 - Graphite Grey
Pull Up	-	233	-	Shaft Grounding	NO
125% of FL	1691	-	0.37	Brake Voltage (DC)	--
75% of FL	1736	-	0.32	Brake Torque (N-M)	--
50% of FL	1760	-	0.31	Mechanical Data	
No Load	1715	-	0.3	Bearing DE Side	6201ZZ
Hazardous Location	Class 1, Div 2, Grp A,B,C,D			Bearing NDE Side	6201ZZ
				Moment of Inertia	-- kg.m2
				Noise Level	Per NEMA dB (A)

CT VFD Range	--	Loaded Torque Curves	--
P1 = INPUT POWER (KW), S = Slip (% of Sync RPM), η = Efficiency (%), cosφ = Power Factor			

Certifications	UL	CSA	DOE
File Numbers	323353	224693	096A
Wiring Diagram	3PH 9 Lead IEC Dual Voltage		

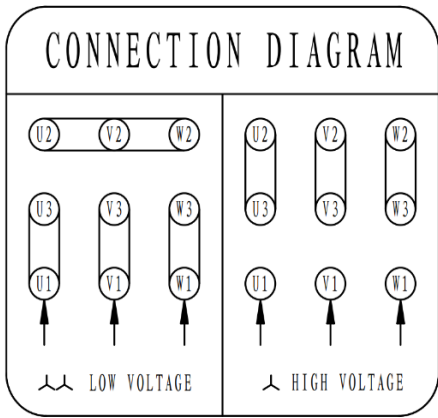

Model Number	GR3-AL-TF-63B35-4-B-D-.18-230 460-60
MFG PN	T 631-4
List Price	--
Base Frame	GR-63B35-AL-TF

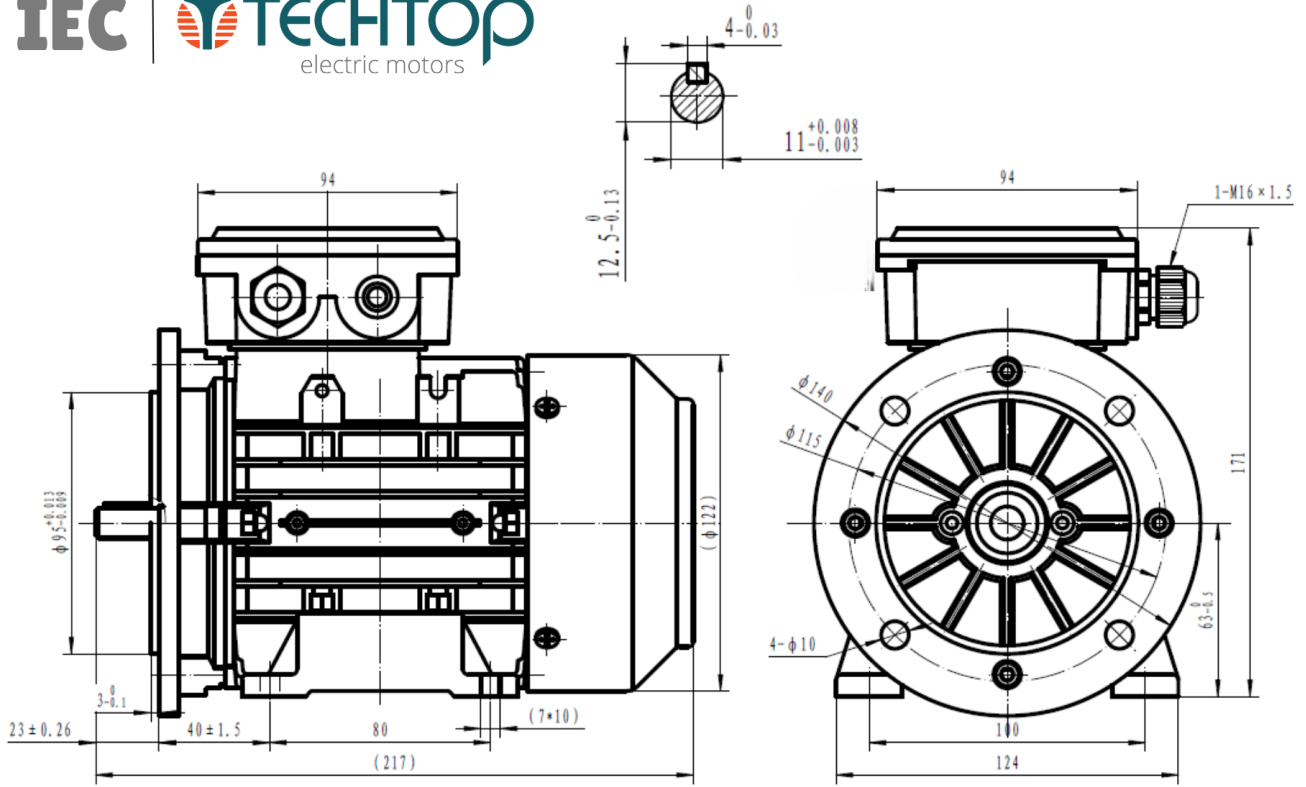

MODEL NUMBER	GR3-63B35-AL-TF	ISSUE DATE:	04/2025
DIMENSIONS	in		
CASTING MATERIAL	ALUMINUM	WWW.TECHTOPIND.COM	

Techtop Industries -2815 Colonnades Court - Peachtree Corners, GA 30071 - Phone: (678) 436-5540

Techtop Industries -2815 Colonnades Court - Peachtree Corners, GA 30071 - Phone: (678) 436-5540