



Model Number GR3-AL-TF-63B3-2-B-D-.35-230|460-60

MFG PN T 632-2

List Price --

All data shown at HIGH voltage setting

Format | STD 3 Phase

Electrical Data				General Data	
Rated Motor Output Power	-- HP			Frame Size	63
Rated Motor Speed	3460 r/min			Enclosure	TEFC
Rated Motor Voltage (3 Phase)	230 460-60 Volts - HZ			Approximate Weight	11.44
Rated Motor Current	1.20/0.60 Amps			NEMA Design	B
Service Factor	1.15			IP Rating	55
KVA Code	J			Insulation Class	F
Nominal Efficiency	72 %			Tropicalization	YES
Nominal Power Factor	0.73 cosθ			Duty	Cont.
Full Load Torque Ft-Lb	0.494192 Ft-Lb			Cable Entry	M16 X 1.5
Temp Rise @ Full Load °C	32.4			Feet Removable	YES
Efficiency Level	IE3 - NEMA Premium			Double Drilled	NO
Load Data	RPM	Trq %FL	Current Amps	Rated Ambient (°C)	40
Locked Rotor	-	280	3.37	Rated Altitude (M)	1000
Breakdown	-	298	-	Coating	7024 - Graphite Grey
Pull Up	-	262	-	Shaft Grounding	NO
125% of FL	3412	-	0.65	Brake Voltage (DC)	--
75% of FL	3498	-	0.52	Brake Torque (N-M)	--
50% of FL	3533	-	0.48	Mechanical Data	
No Load	--	-	0.4	Bearing DE Side	6201ZZ
Hazardous Location	Class 1, Div 2, Grp A,B,C,D			Bearing NDE Side	6201ZZ
				Moment of Inertia	-- kg.m2
				Noise Level	Per NEMA dB (A)

CT VFD Range	--	Loaded Torque Curves	--
P1 = INPUT POWER (KW), S = Slip (% of Sync RPM), η = Efficiency (%), cosφ = Power Factor			

Certifications	UL	CSA	DOE
File Numbers	323353	224693	096A
Wiring Diagram	3PH 9 Lead IEC Dual Voltage		

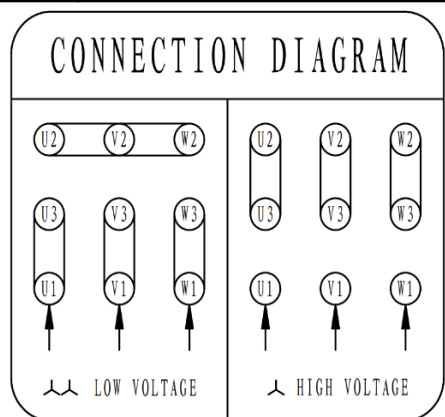

Model Number	GR3-AL-TF-63B3-2-B-D-.35-230 460-60
MFG PN	T 632-2
List Price	--
Base Frame	GR-63B3-AL-TF

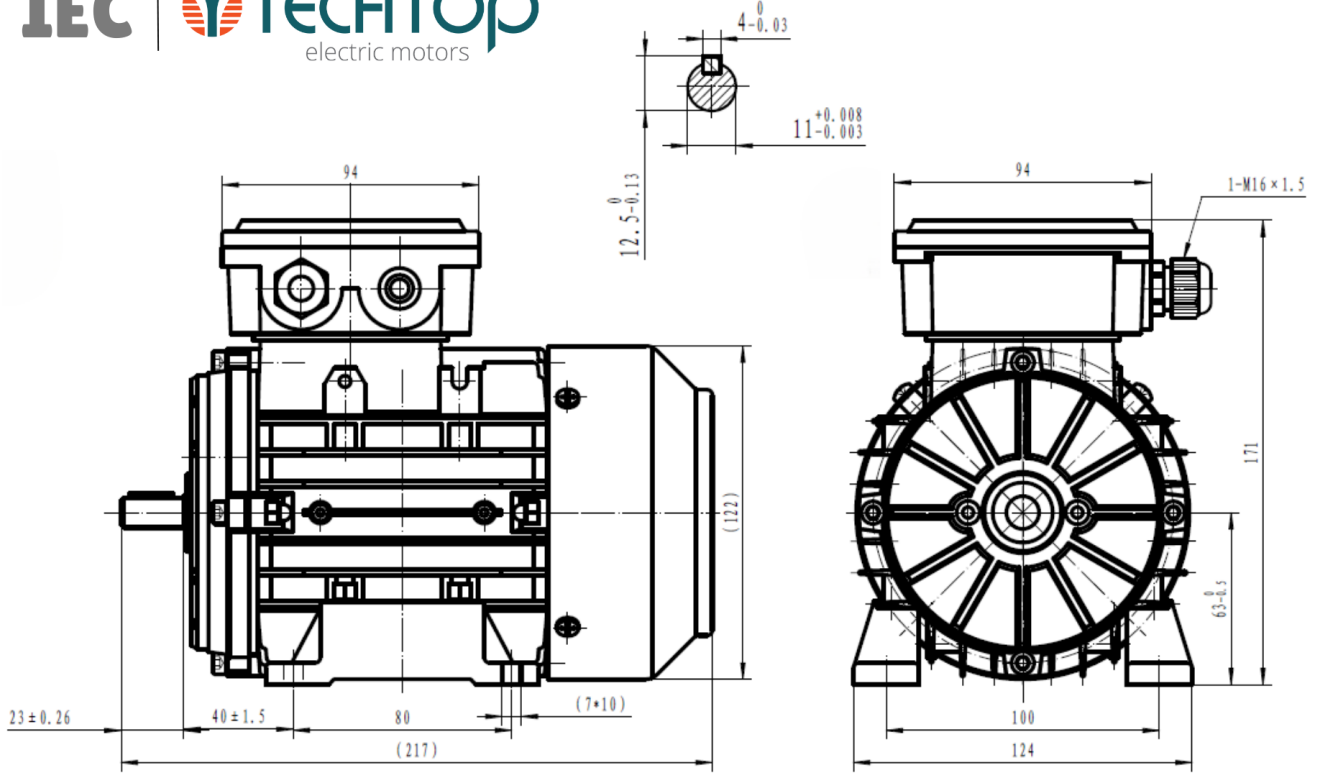

MODEL NUMBER	GR3-63B3-AL-TF	ISSUE DATE:	04/2025
DIMENSIONS	in		
CASTING MATERIAL	ALUMINUM	WWW.TECHTOPIND.COM	

Techtop Industries -2815 Colonnades Court - Peachtree Corners, GA 30071 - Phone: (678) 436-5540

Techtop Industries -2815 Colonnades Court - Peachtree Corners, GA 30071 - Phone: (678) 436-5540